

东莞市志展五金塑胶制品有限公司

DongGuan ZhiZhan Hardware Plastic Products Co., LTD

TEL:0769-81802125

FAX:0769-81802126

DOCUMENT NO.

RDE0286A

SERIAL NO.

C1302H02-NP

- * Material:Nylon 66 UL 94V-0
- * Unit quantity:1000 Pcs/Bag

Specifications:

Poles	2-10Poles
Plug Diameter	Ø1.28mm
Rated Voltage	300V AC,DC
Rated Current	2-5A
Withstand Voltage	1500V AC/minute
Contact Resistance	10mΩ (MAX).
Insulation Resistance	1000mΩ (MIN)
Temperature Range	-25°C ~ +85°C*
Applicable Wire Range	AWG #22~#28

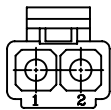
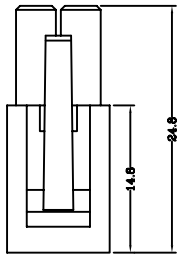
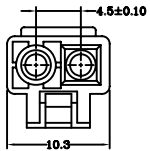

C1302H02-1x2P

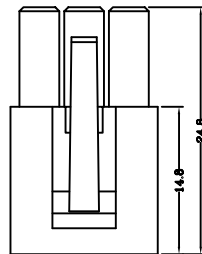
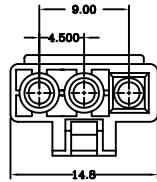

C1302H02-1x3P

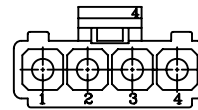
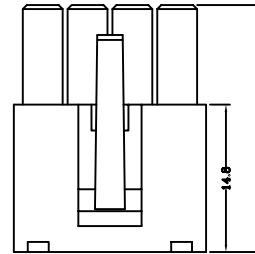
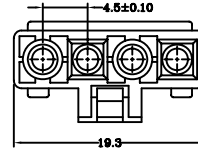

C1302 Series Ø1.28mm receptacle crimp terminal

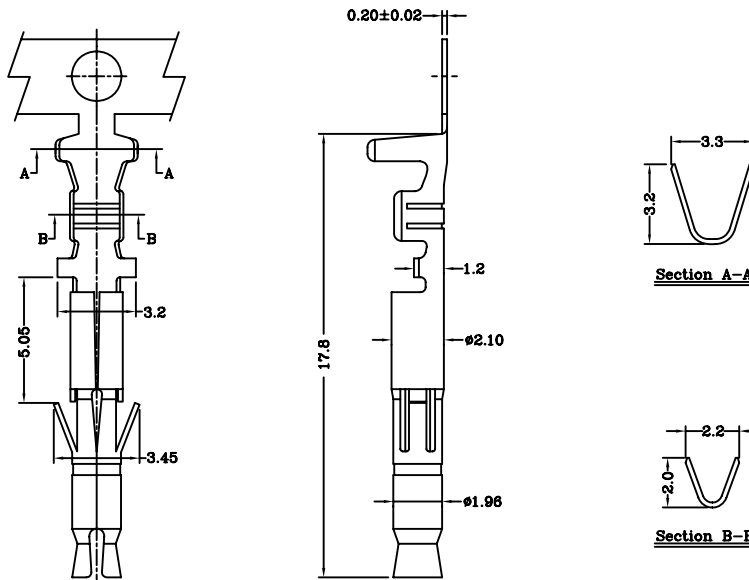

Specifications & Ordering Information:

Part No	Wire Range	Insulation O.D.	Material	Finish	Qty/reel
C1302TOP-2	AWG #20~#26	2.70mm(max)	Phosphor branze	Tin-plated	8,000 PCS
C1302TOB-2	AWG #20~#26	2.70mm(max)	Brass	Tin-plated	8,000 PCS