

深圳市占開科技有限公司

ShenZhen ZhanKai Technology CO.,LTD

TEL:0769-81802125 FAX:0768-81802126

DOCUMENT NO.

RDE0396A

SERIAL NO.

A2003H02-1xNP

Material:PPO UL 94V-1

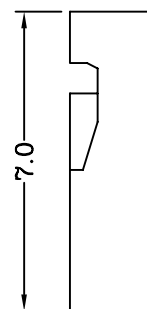
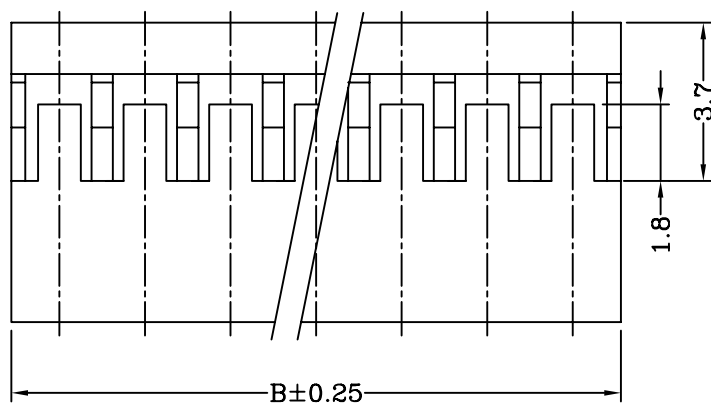
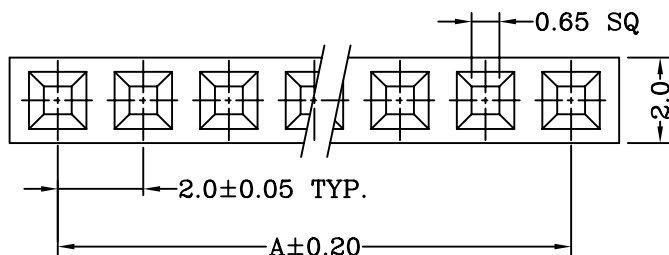

Dimensional & Ordering Information:

Circuits	Part No	Dimensions		Pcs/Bag
		A	B	
2	A2003H02-1x 2P	2.00	4.25	1000
3	A2003H02-1x 3P	4.00	6.25	1000
4	A2003H02-1x 4P	6.00	8.25	1000
5	A2003H02-1x 5P	8.00	10.25	1000
6	A2003H02-1x 6P	10.00	12.25	1000
7	A2003H02-1x 7P	12.00	14.25	1000
8	A2003H02-1x 8P	14.00	16.25	1000
9	A2003H02-1x 9P	16.00	18.25	1000
10	A2003H02-1x 10P	18.00	20.25	1000
11	A2003H02-1x 11P	20.00	22.25	1000
12	A2003H02-1x 12P	22.00	24.25	1000
13	A2003H02-1x 13P	24.00	26.25	1000
14	A2003H02-1x 14P	26.00	28.25	1000
15	A2003H02-1x 15P	28.00	30.25	1000

REV.	ECN NO.	UNIT	TOLERANCE	PROJECTION	DRAWING	CHECK	APPROVAL
△	NEW DRAWING	mm	*** ±0.08		余望明	—————	邹朝辉
△			** ±0.15				
△			* ±0.25				

深圳市占開科技有限公司

ShenZhen ZhanKai Technology CO.,LTD

TEL:0769-81802125

FAX:0768-81802126

DOCUMENT NO.

RDE0325A

SERIAL NO.

A2003H02-2xNP

Material:PPO UL 94V-1

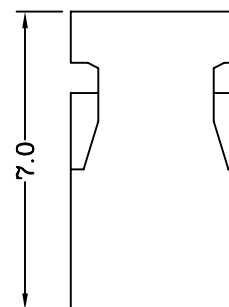
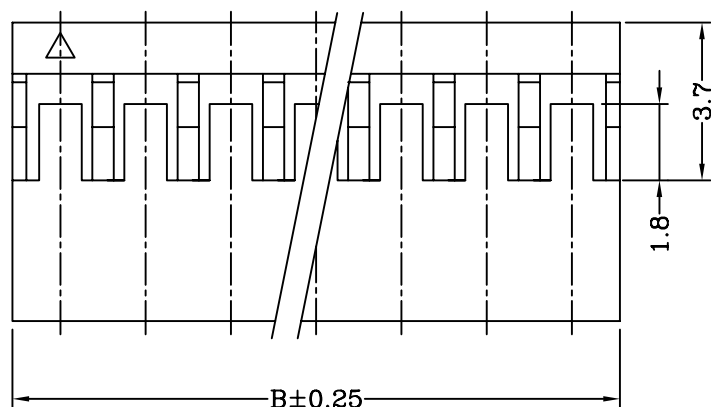
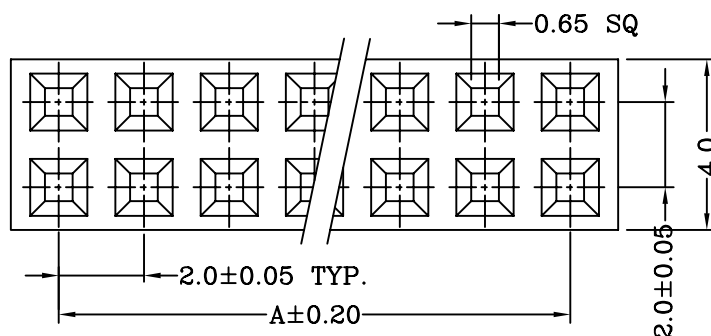

Dimensional & Ordering Information:

Circuits	Part No	Dimensions		Pcs/Bag
		A	B	
4	A2003H02-2x2P	2.00	4.25	1000
6	A2003H02-2x3P	4.00	6.25	1000
8	A2003H02-2x4P	6.00	8.25	1000
10	A2003H02-2x5P	8.00	10.25	1000
12	A2003H02-2x6P	10.00	12.25	1000
14	A2003H02-2x7P	12.00	14.25	1000
16	A2003H02-2x8P	14.00	16.25	1000
18	A2003H02-2x9P	16.00	18.25	1000
20	A2003H02-2x10P	18.00	20.25	1000
22	A2003H02-2x11P	20.00	22.25	1000
24	A2003H02-2x12P	22.00	24.25	1000
26	A2003H02-2x13P	24.00	26.25	1000

REV.	ECN NO.	UNIT	TOLERANCE	PROJECTION	DRAWING	CHECK	APPROVAL
A	NEW DRAWING	mm	*** ±0.08		余望明	—————	邹朝辉
B			** ±0.15				
			* ±0.25				

深圳市占開科技有限公司

ShenZhen ZhanKai Technology CO.,LTD

TEL:0769-81802125

FAX:0768-81802126

DOCUMENT NO.

RDE0183B

SERIAL NO.

A2003T

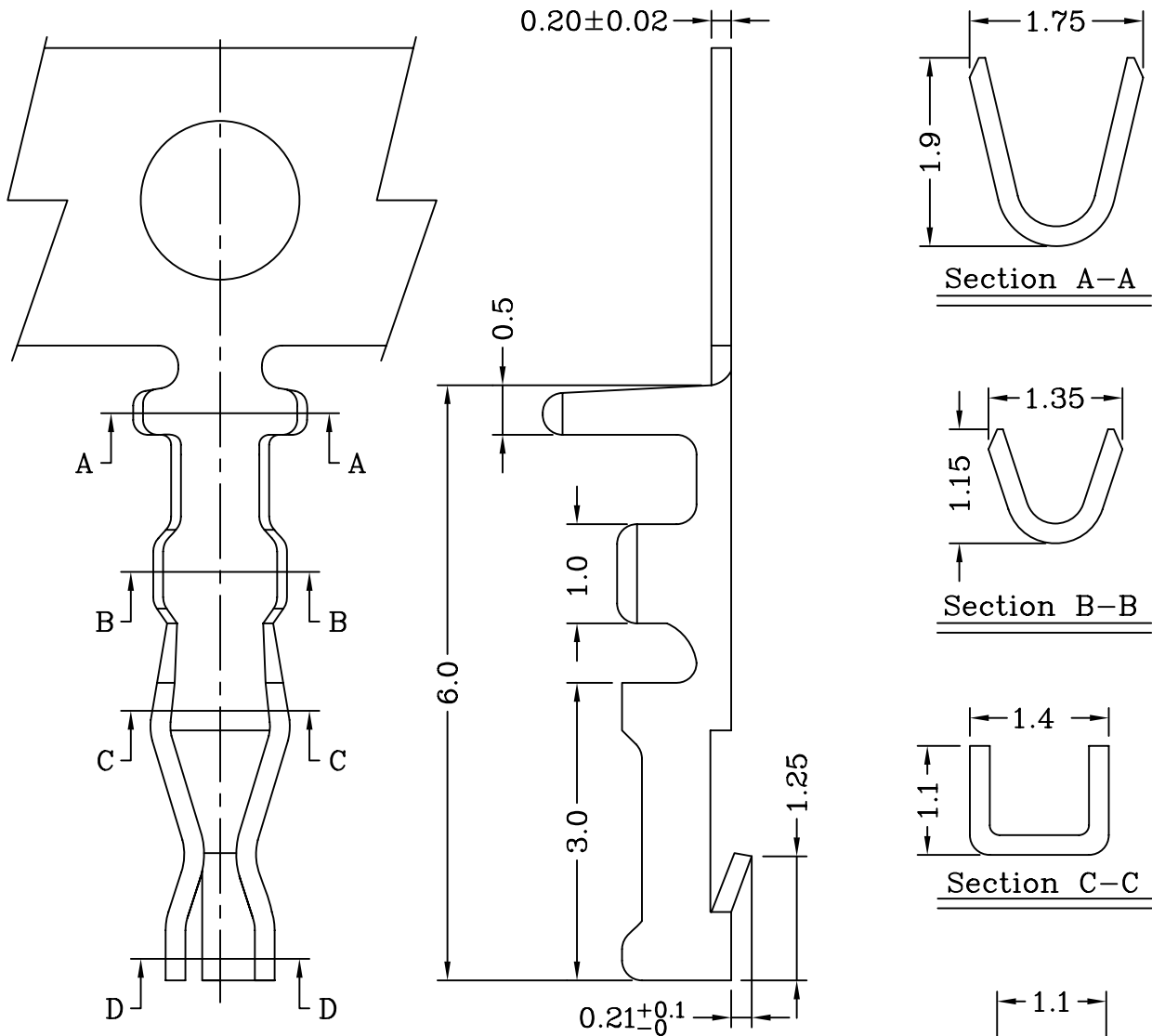

Specifications & Ordering Information:

Part No	Wire Range	Material	Finish	Qty/reel
A2003TOB-2	AWG #30~#26	Brass	Tin-plated	20,000 PCS
A2003TOB-00	AWG #30~#26	Brass	Gold-Flash	20,000 PCS
A2003TOB-0D	AWG #30~#26	Brass	15 m ² Gold plated	20,000 PCS
A2003TOP-00	AWG #30~#26	Phosphor Bronze	Gold-Flash	20,000 PCS

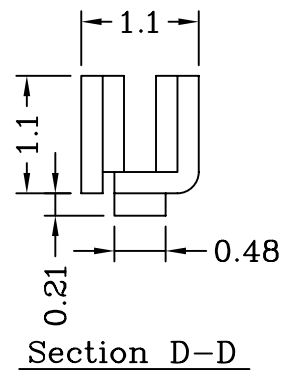

REV.	ECN NO.	UNIT	TOLERANCE	PROJECTION	DRAWING	CHECK	APPROVAL
△	NEW DRAWING	mm	*** ±0.08		余望明	—	邹朝辉
△			** ±0.15				
△	N1999109		* ±0.25				